

轴承座

d1 90-93.663mm-SNV180-L+2220-K-M-C3+H320X310

参数信息:

型号:

轴承: SNV180-L

座轴承: 2220-K-M-C3

紧定套: H320X310

止动环2件: FRM180/1
2双唇密封圈: DH520X3
10带O形圈的迷宫密封
圈: TSV520X
310毛毡密封: FSV520X3
10V型圈: DHV520
X310Taconite密封: TCV520X
310

轴承盖: DKV180

质量m kg: 17

尺寸:

dmm: 92.075

dinch: 3 5/8

a: 380

g: 160

h: 223

b: 110

c: 40

D: 180

g: 177.3

g: 168

g: 203

g: 16

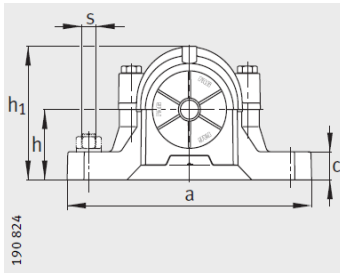
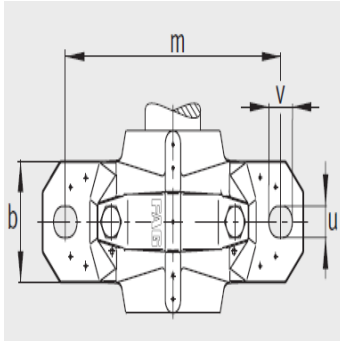

- ① 定位轴承
② 浮动轴承

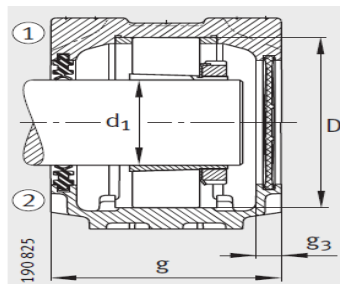

双唇密封 DH
端盖 DKV

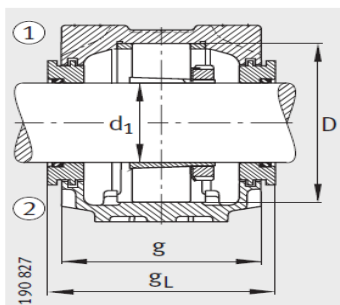

迷宫密封 TSV

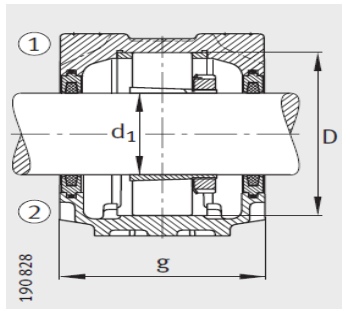

毛毡密封 FSV

h :	112
m :	320
u :	26
v :	32
smm :	M24
sinch :	7/8

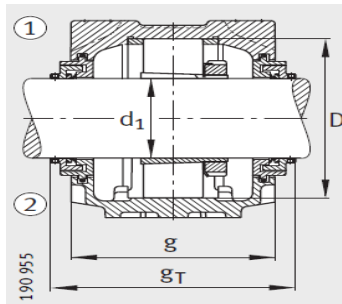

Taconite 密封 TCV

: