

轴承座

d 40-55mm-SNV090-L+22308-E1+KM8

参数信息:

型号:

轴承座: SNV090-L

轴承: 22308-E1

锁紧螺母: KM8

止动垫圈: MB8

止动环 2件: FRM90/4

双唇密封圈: DH308

带O形圈的迷宫密封圈:

毛毡密封: FSV308

V型圈: DHV308

轴承盖: DKV090

质量m kg: 3.1

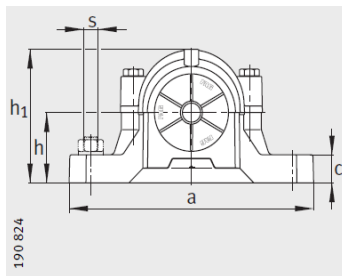
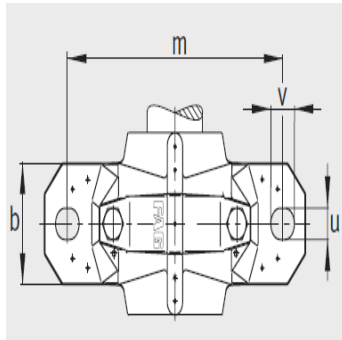

- ① 定位轴承
② 浮动轴承

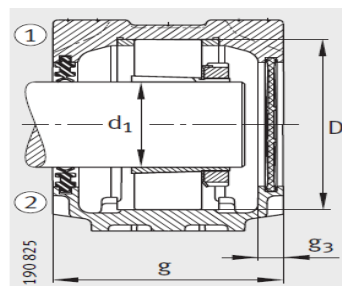

双唇密封 DH
端盖 DKV

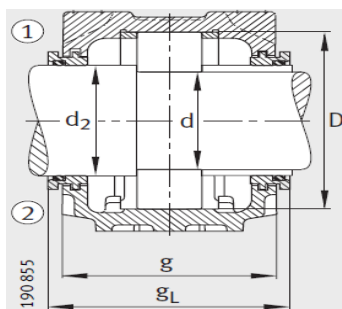

迷宫密封 TSV

尺寸:

d: 40

a: 205

g: 100

h: 117

d: 50

b: 60

c: 25

D: 90

g: 114

g: 106

g: 12.5

h: 60

m: 170

u: 15

v: 20

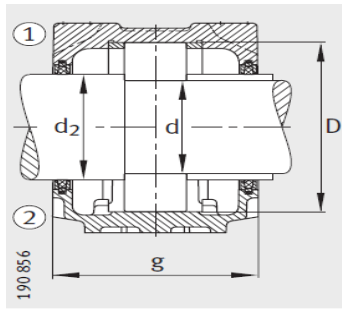

毛毡密封 FSV

smm : M12

sinch : 1/2

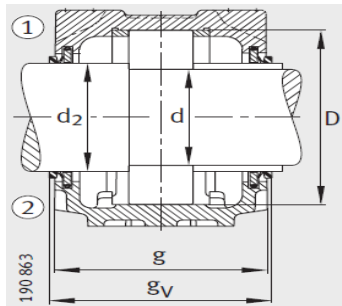

V型圈密封 DHV

: